

# A to Z

for Very Young ESL Learners

Global Edition



By Donald, Robert, and Michael Kinney

Step-by-Step Lessons  
Alphabet/Phonics Skills  
Makes Learning Fun!



Date / /



A a

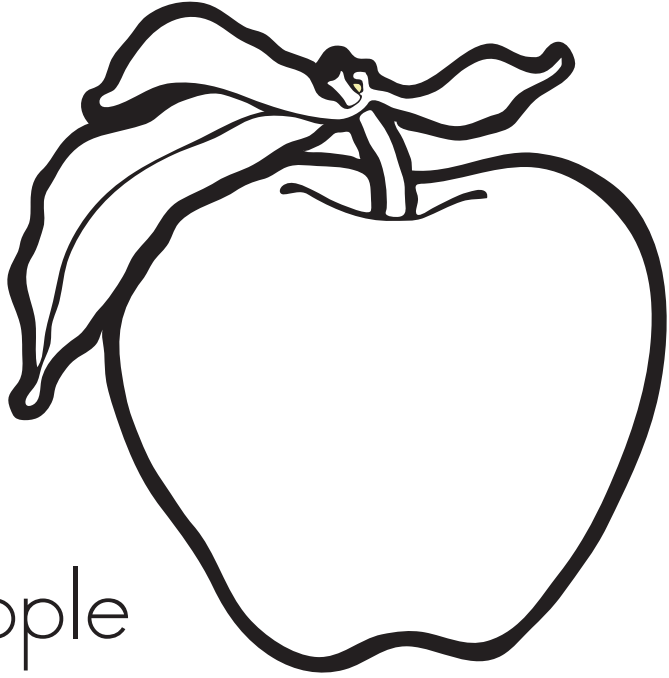

apple

**sample page**

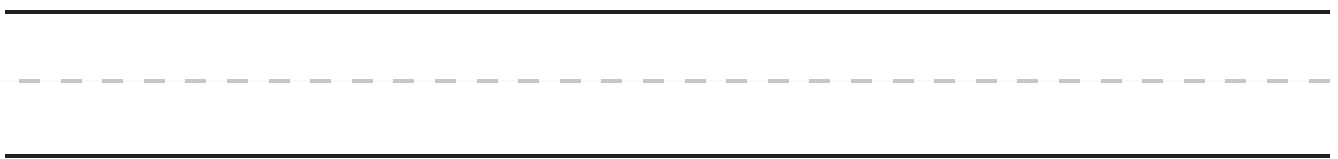
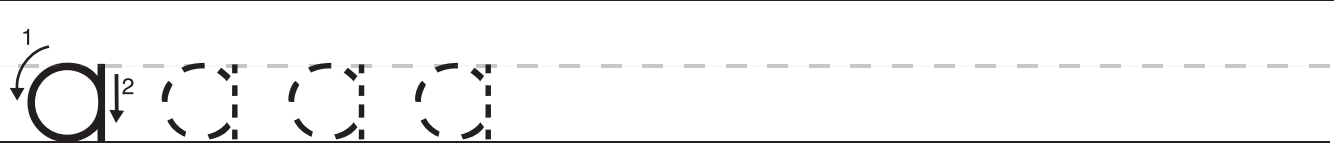
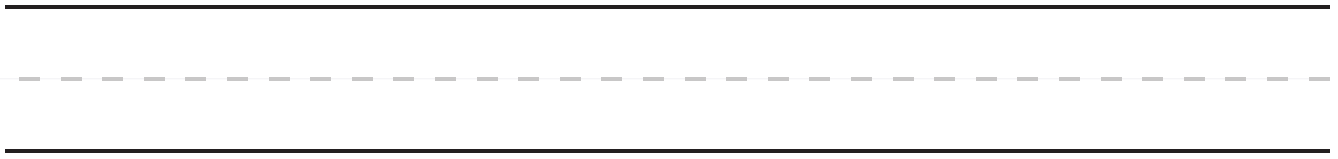
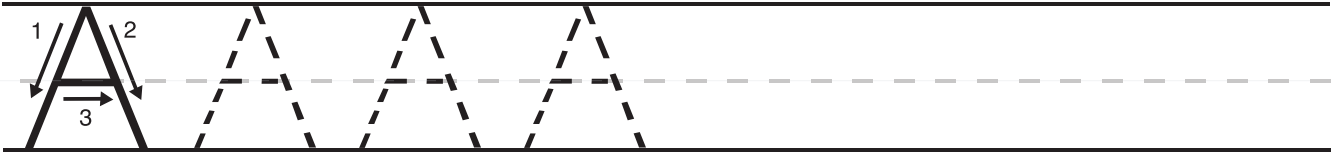

Date / /



book

Bb

**sample page**

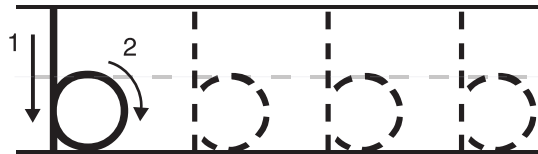
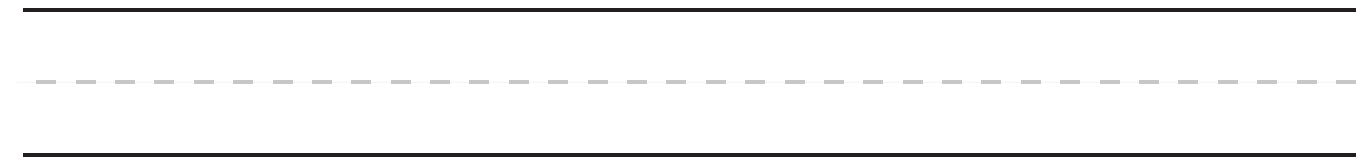
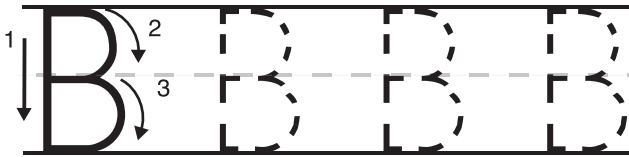

Date / /



A  Let's write!

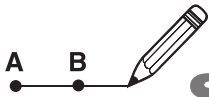
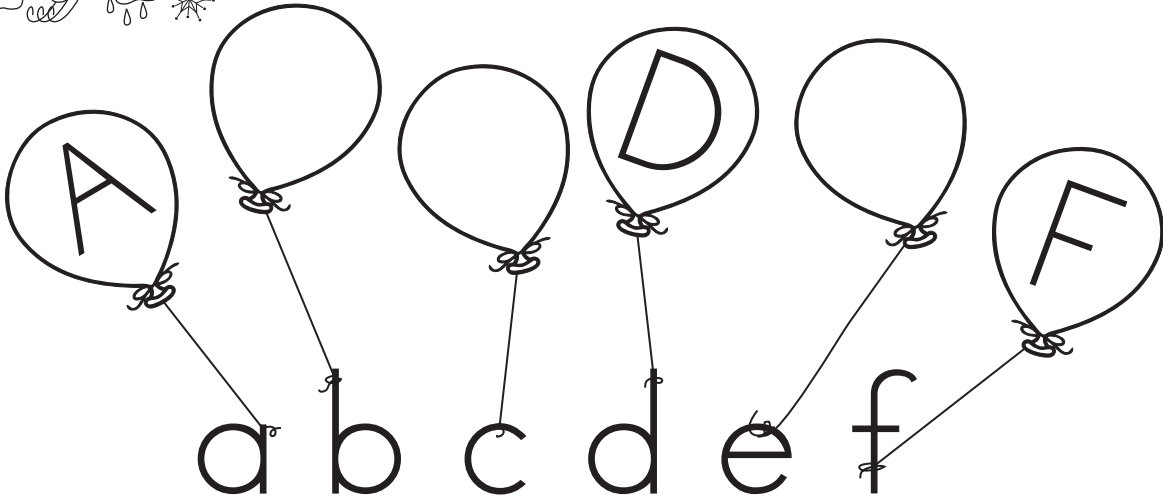

Connect the dots!

sample page

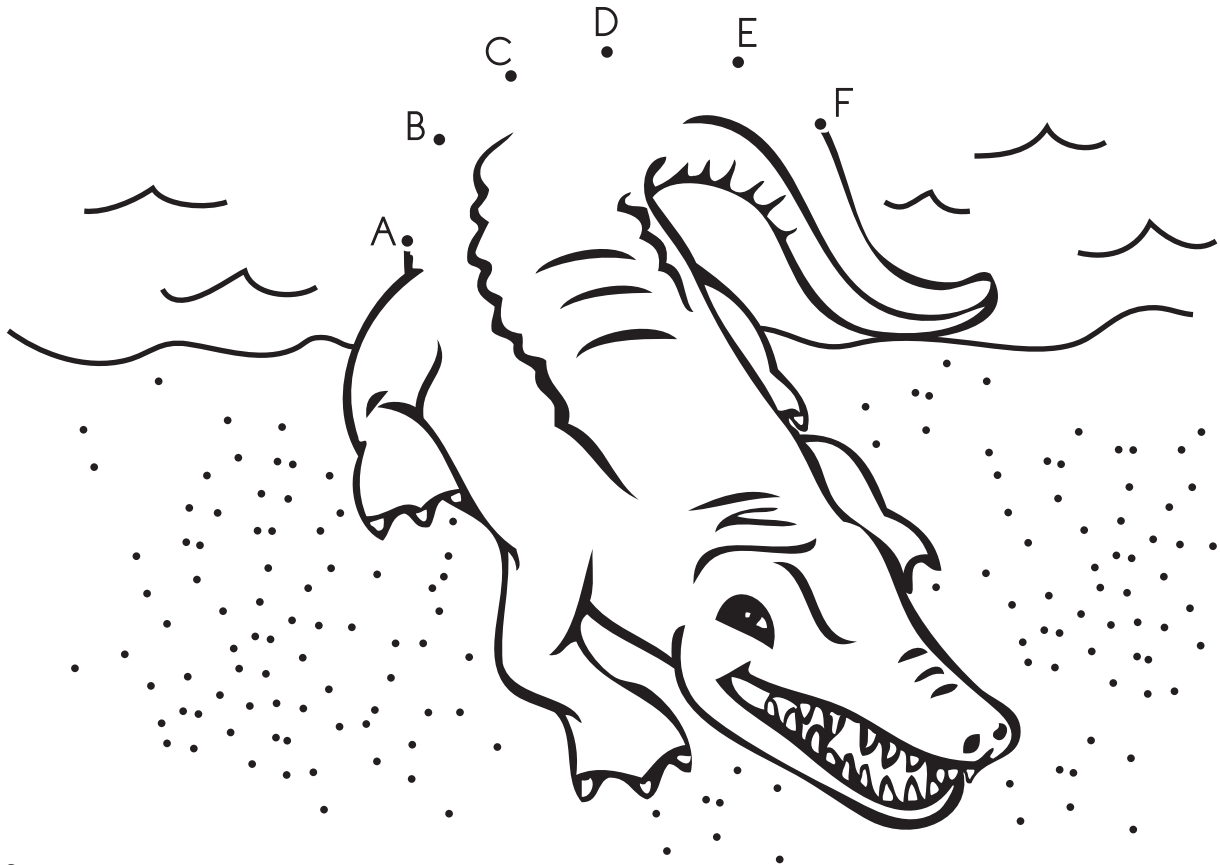

Date / /



Help the hen find her eggs!

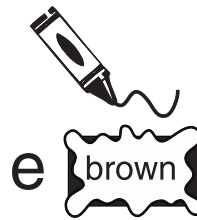

sample page

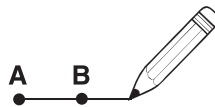
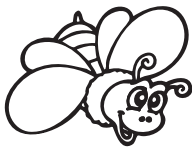

Help the bee find the flower!

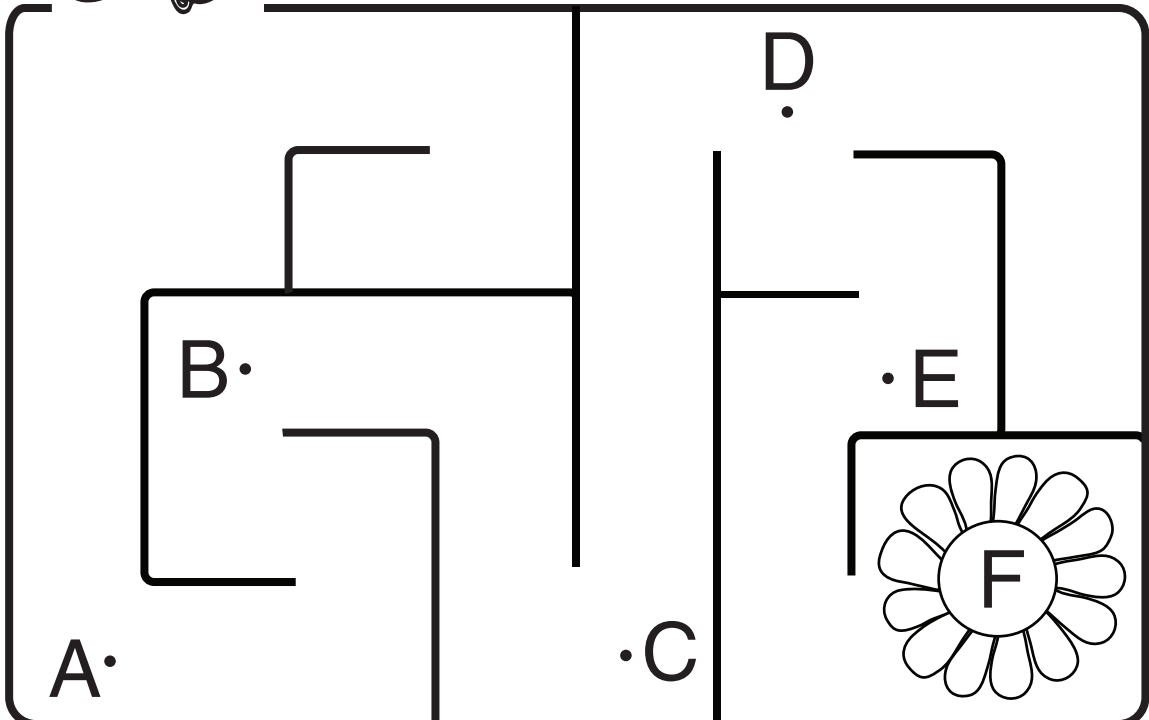

Date / /



Match the big and small letters!

U W X S V

v w u x s

**sample page**

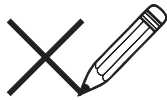

Draw an X on the mistakes!

A B C D E F

---

G H I J K L

---

M N O P Q R

---

S T U V W X



\_\_\_\_\_ Institution

Upon recommendation of the English Instructor, this

# Certificate of Completion

is awarded to

\_\_\_\_\_ Name

in recognition of the completion of A to Z.

\_\_\_\_\_ Date

\_\_\_\_\_ Program Director

\_\_\_\_\_ English Instructor